

ComfoAir Standard 300

ComfoAir Standard 375

Installer manual



All rights reserved.

This manual has been compiled with the utmost care. The publisher cannot be held liable for any damage caused as a result of missing or incorrect information in this manual. In case of disputes the Dutch version of these instructions will be binding.

Table of Contents

	Preface	5
1	Introduction	5
	1.1 CE certification and warranty	5
	1.1.1 Guarantee conditions	5
	1.1.2 Liability	5
	1.2 Safety	6
	1.2.1 Safety regulations	6
	1.2.2 Safety provisions and measures	6
2	For the Installer	7
	2.1 ComfoAir Standard configuration	7
	2.2 Technical specifications	8
	2.3 Dimension sketch	10
	2.4 Installation conditions	10
	2.5 Installation of the ComfoAir Standard	11
	2.5.1 Transport and unpacking	11
	2.5.2 Checking the delivery	11
	2.6 Mounting of the ComfoAir Standard	11
	2.6.1 Mounting on the wall	11
	2.6.2 Connection of the air ducts	12
	2.6.3 Connection of the condensation drain	12
	2.7 Commissioning the ComfoAir Standard	13
	2.7.1 Display on the unit	13
	2.7.2 P menus for the user	14
	2.7.3 P menus for the installer	15
	2.8 Programming air specifications	18
	2.9 Maintenance by the installer	19
	2.9.1 Inspecting and cleaning the heat exchanger	19
	2.9.2 Inspecting and cleaning the fans	20
	2.9.3 Inspecting and cleaning the preheater element filter	20
	2.10 Malfunctions	21
	2.10.1 Malfunction alerts on the digital operating device	21
	2.10.2 3-position switch with malfunction indicators	21
	2.10.3 What to do in the event of a malfunction / Trouble shooting	22
	2.10.4 Malfunctions (or problems) without alerts	28
	2.11 Service parts	29
	2.12 Wiring diagram: ComfoAir Standard - LEFT-HAND version	30
	2.13 Wiring diagram: ComfoAir Standard - RIGHT-HAND version	31



Carefully read this manual before use.

This manual provides all the information required for safe and optimal installation and maintenance of the ComfoAir Standard 300/ComfoAir Standard 375. It is also intended as a reference for servicing, so that this can be carried out in a responsible manner. The unit is subject to continuous development and improvement. As a result, the ComfoAir Standard 300/ComfoAir Standard 375 may slightly differ from the descriptions.

NOTE

This manual has been compiled with the utmost care. However, no rights can be derived from it. In addition, we at all times reserve the right to change the contents of this manual, without prior notice.

The following pictograms are used in this document:

Symbol	Bedeutung
	Point of attention.
	Risk of compromised performance or damage to the ventilation system.
	Risk of personal injury.

1 Introduction

The name of the unit is ComfoAir Standard 300/ComfoAir Standard 375. In the following it will be referred to as ComfoAir Standard.

The ComfoAir Standard is a balanced ventilation system with heat recovery in order to create healthy, balanced and energy-efficient ventilation in houses. The ComfoAir Standard has a CE marking on the identification plate. The identification plate can be found on top of the ComfoAir Standard.

1.1 CE certification and warranty

1.1.1 Guarantee conditions

The ComfoAir Standard is covered by a manufacturer's warranty for a period of 24 months after fitting up to a maximum of 30 months after the date of manufacture. Warranty claims may only be submitted for material faults and/or construction faults arising during the warranty period. In the case of a warranty claim, the ComfoAir Standard must not be dismantled without written permission from the manufacturer. Spare parts are only covered by guarantee, if they were supplied by the manufacturer and have been installed by an approved installer.

The warranty becomes invalid if:

- The guarantee period has elapsed;
- The unit is used without filters;
- Parts are used that have not been supplied by the manufacturer;
- Non-authorized changes or modifications have been made to the unit.

1.1.2 Liability

The ComfoAir Standard has been designed and manufactured for use in "balanced ventilation systems". Any other use is deemed unintended use and can lead to damage to the ComfoAir Standard or personal injury, for which the manufacturer cannot be held liable.

The manufacturer is not liable for any damage originating from:

- Non-compliance with the safety, operating and maintenance instructions in this manual.
- The use of components not supplied or recommended by the manufacturer. Responsibility for the use of such components lies entirely with the installer.
- Normal wear and tear.



1.2 Safety

1.2.1 Safety regulations

Always comply with safety regulations in this manual. Non-compliance with the safety regulations, warnings, notes and instructions in this manual can cause personal injury or damage to the ComfoAir Standard.

- The ComfoAir Standard may only be installed, connected, rendered operational and maintained by an appropriately approved installer, unless otherwise indicated in this manual;
- Installation of the ComfoAir Standard must be carried out in accordance with the general and locally applicable construction, safety and installation instructions of the local council, electricity and water boards or other agencies;
- Always install the equipment according to the latest regulations for installation of your country.
- The entire installation must comply with the applicable (safety) regulations as stated in:
 - local EU Standard on safety provisions for low-voltage installations;
 - Manufacturer's assembly/ installation manual.
- Always obey the safety regulations, warnings, comments and instructions as prescribed in this manual at all times;
- Keep this manual with the ComfoAir Standard throughout its life;
- Instructions with regard to cleaning or replacing the filters of the intake and exhaust valves must be carefully observed;
- The specifications stated in this document may not be changed;
- Modifying the ComfoAir Standard is not allowed;

- The ComfoAir Standard is only suitable for connection to 230V 50Hz mains;
- It is recommended to take out a maintenance contract so that the unit is checked on a regular Basic. The supplier can provide a list of registered installers nearby.

1.2.2 Safety provisions and measures

- The ComfoAir Standard cannot be opened without using tools;
- It should not be possible to touch the fans, therefore ducting must be connected to the ComfoAir Standard at a minimum duct length of 900mm.

2 For the Installer

2.1 ComfoAir Standard configuration

The standard ComfoAir Standard configuration consists of:

- External casing (A) of coated sheeting;
- Interior (B) of high-quality, expanded polypropylene (E)PP;
- 4 connections (C) for the air ducts;
- 2 plate filters (D) for air purification. Filter classification: ISO Coarse/ ISO ePM1 (ISO 16890 compliant);
- 2 energy-efficient DC motors (E) with high-efficient fan;
- HE (High efficient) heat exchanger (F);
- Control circuit board (H1) with connections for the fans, the bypass, the Preheater element, temperature sensors (T1 to T4), the 3-position switch with or without malfunction indicator (optional) and the bathroom switch (optional);
- Identification plate (I) detailing information on the ComfoAir Standard (not visible);
- Condensation drain (J) to drain the condensation of the warm return air;
- Sticker (K) detailing the air connections (not visible);
- Cable for power supply with 230V 5 core connection (L);
- Display (M) to read data, and for programming procedures.

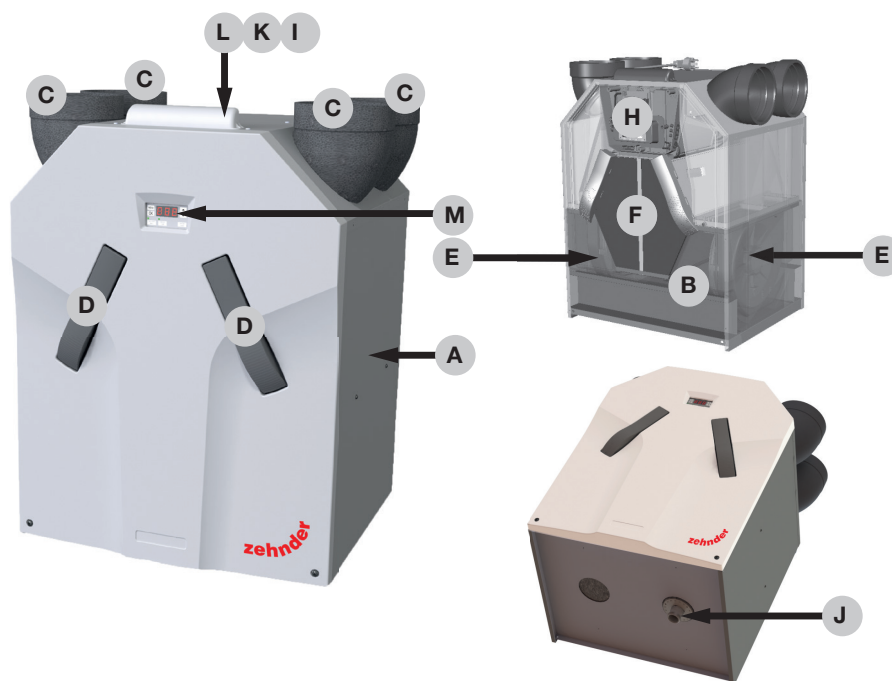

2.2 Technical specifications

	ComfoAir Standard 300	ComfoAir Standard 375	ComfoAir Standard 375 ERV
Performance (EN 13141-7)			
Maximum declared airflow (q_{vd})	300 m ³ /h	375 m ³ /h	422 m ³ /h
Thermal Efficiency (humidity) ($0,7 \times q_{vd}$)	87%	86%	74% (60%)
Specific fan power	0,20 W/(m ³ /h)	0,23 W/(m ³ /h)	0,27 W/(m ³ /h)
Power consumption (q_{vd})	93,2 W	142,3 W	202 W
Connection data			
Shape air connection	Round	Round	Round
Dimension air connection	Inner: 160 mm (151 mm) Outer: 180 mm	Inner: 160 mm (151 mm) Outer: 180 mm	Inner: 160 mm (151 mm) Outer: 180 mm
Dimensions syphon	32 mm / 1 ¼"	32 mm / 1 ¼"	32 mm / 1 ¼"
Connection syphon	Tube / thread connection	Tube / thread connection	Tube / thread connection
Electrical data			
Maximal power consumption	230 V ±10%, 1 fase, 50 Hz	230 V ±10%, 1 fase, 50 Hz	230 V ±10%, 1 fase, 50 Hz
Can be used with current (A)	10	10	10
Material specifications			
Housing	Coated sheet steel and ABS	Coated sheet steel and ABS	Coated sheet steel and ABS
Inside	EPP and ABS	EPP and ABS	EPP and ABS
Heat exchanger	Polystyreen	Polystyreen	n.a.
Enthalpy exchanger	n.a.	n.a.	Polyethyleen-polyether-copolymeer
General			
IP-classification	IP40	IP40	IP40
ISO-classification	B	B	B
Weight	42 kg	42 kg	42 kg
Filter class	ePM1 (F7) / Coarse (G4)	ePM1 (F7) / Coarse (G4)	ePM1 (F7) / Coarse (G4)

Point [-]	Instel. [%]	Qv [m³/h]	P [Pa]	l [A]	Pe [W]	cos phi [-]	Supply dB(A)	Extract dB(A)	Casing dB(A)
1	30	125	13	0,15	16	0,43	49	35	34
2	34	125	32	0,18	19	0,44	52	39	37
3	40	125	61	0,21	24	0,46	54	41	40
4	46	210	29	0,33	39	0,51	59	45	44
5	49	210	50	0,38	45	0,5	60	46	45
6	53	200	92	0,41	49	0,52	61	48	47
7	56	185	131	0,45	55	0,52	64	54	49
8	57	263	50	0,52	64	0,53	63	53	48
9	64	290	60	0,65	81	0,54	66	52	51
10	69	260	151	0,76	95	0,54	68	52	53
11	74	240	229	0,85	108	0,54	69	56	55
12*	83	375	100	1,22	156	0,55	70	58	58
13*	91	340	258	1,53	196	0,55	73	58	59
14*	95	300	351	1,53	197	0,55	74	59	61

- * Only for the ComfoAir Standard 375
- Sound power reference level is 1pW.
- Sound pressure reference level is 20 µPa.
- Sound power levels measured according to ISO 3741:2010.
- Extract noise measured according ISO 5135:1997 (L w values include end reflection correction (therefore, values are in duct values)).
- Supply noise measured according ISO 5135:1997 (L w values include end reflection correction (therefore, values are in duct values)).
- cos phi with preheater turned o (if present)

2.3 Dimension sketch

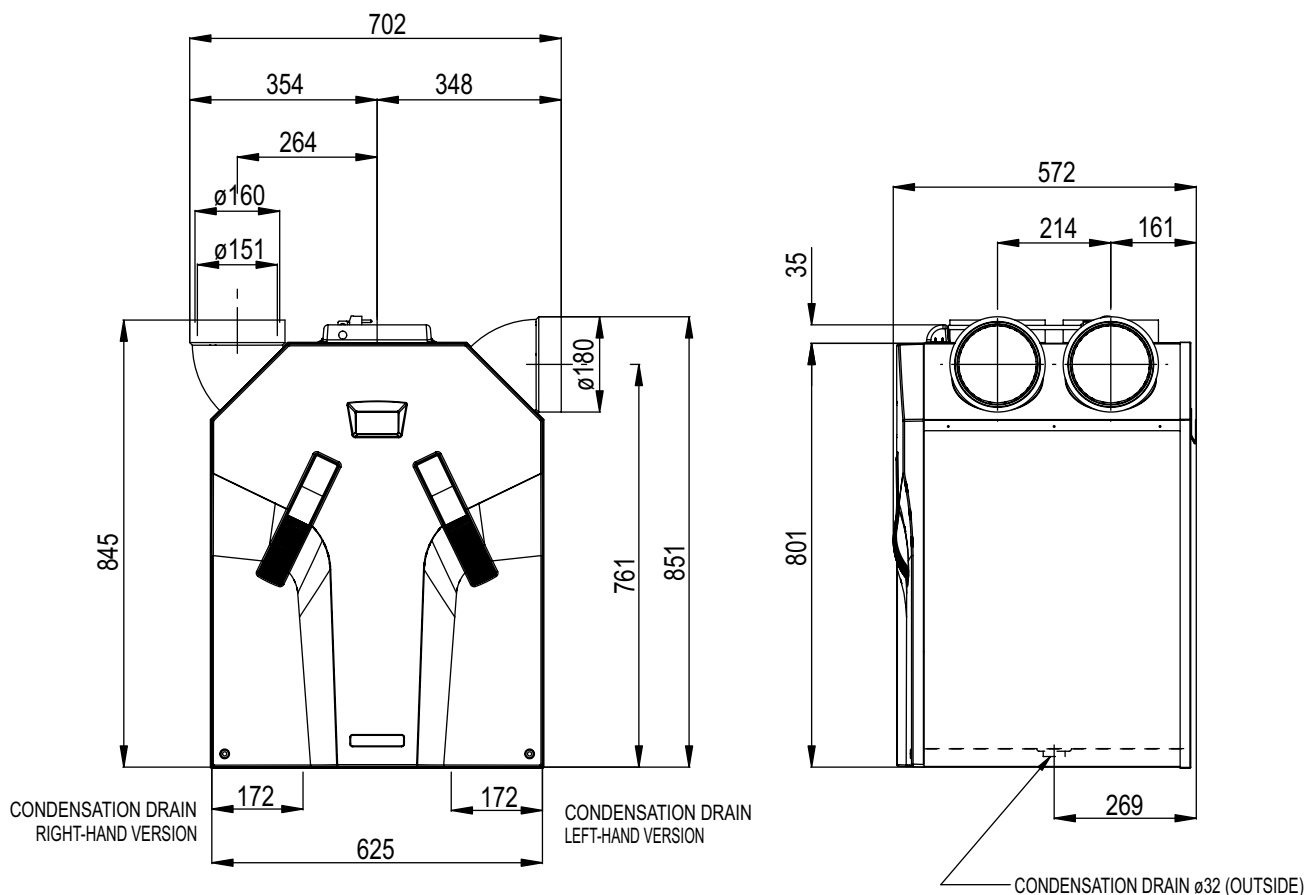

2.4 Installation conditions

In order to determine whether the ComfoAir Standard can be installed in a certain area, the following aspects must be taken into account:

- The ComfoAir Standard must be installed according to the general and locally applicable safety and installation regulations of power and water companies, as well as the instructions in this manual.
- The system must be fitted to allow sufficient room around the ComfoAir Standard for the air connections and supply and exhaust ducts as well as for carrying out maintenance activities.
- The ComfoAir Standard must be installed in a frost-free space. The condensation must be drained off frost-free, at a gradient and incorporate a 'U' bend.

👉 We do not recommend installing the ComfoAir Standard in areas with a higher average humidity (such as bathroom or toilet). This will prevent condensation on the outside of the ComfoAir Standard.

- The room must offer the following provisions:
 - Air duct connections.
 - 230V electrical connection.
 - Provisions for the condensation drain.
 - Wiring for an wired 3-position switch

(optional).

- Within a distance of 1 meter or at most the length of the fixed (or supplied) power cable (both 3-core and 5-core), an earthed wall outlet must be available.
- A gap should be left near the doors in order to ensure effective and draughtfree airflow in the house. A gap under the inside doors must be at least 10mm.



If these openings are obstructed, due to draught excluders or deep-pile carpet, the airflow in the house will stagnate. As a result, system performance will be compromised or fail altogether.

2.5 Installation of the ComfoAir Standard

2.5.1 Transport and unpacking

Take the necessary precautions when transporting and unpacking the ComfoAir Standard.

 **Make sure the packing material is disposed of in an environmentally friendly manner.**

2.5.2 Checking the delivery

Contact your supplier immediately in case of damage or an incomplete delivery. The delivery must include:

- ComfoAir Standard;
Check the identification plate to ensure that it is the required type.
- 4 x 450 connection bends;
- Mounting bracket;
- Documentation.

The ComfoAir Standard is supplied in the following types:

Type
ComfoAir Standard 300 L
ComfoAir Standard 300 R
ComfoAir Standard 300 L PRH
ComfoAir Standard 300 R PRH
ComfoAir Standard 375 L
ComfoAir Standard 375 R
ComfoAir Standard 375 L PRH
ComfoAir Standard 375 R PRH
ComfoAir Standard 375 ERV L
ComfoAir Standard 375 ERV R
ComfoAir Standard 375 ERV L PRH
ComfoAir Standard 375 ERV R PRH

Meaning of the suffixes:

- * L = Left version
- * R = Right version
- * PRH = Contains a preheater element by default

2.6 Mounting of the ComfoAir Standard

2.6.1 Mounting on the wall

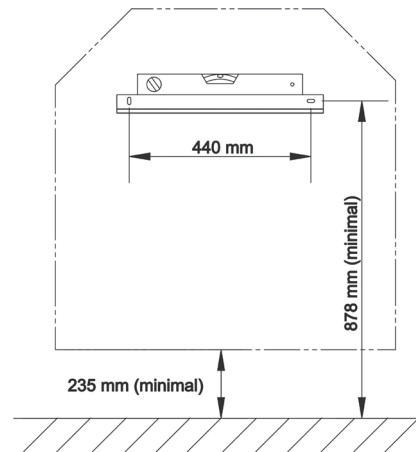

Mount the ComfoAir Standard against a wall with a minimum mass of 200 kg/m². For other types of wall, we recommend using the Zehnder mounting frame on the floor (available as an optional extra). This reduces contact noise as much as possible. The ComfoAir Standard does not require any space at the sides for effective operation.

 **Do not mount the side of the ComfoAir Standard against the wall due to the risk of impact sound.**

1. Fasten the mounting bracket to the wall. Make sure it is level and at least 878mm from the floor (depending on the type of condensation drain selected).

 **Leave a minimum space of 1m in front of the ComfoAir Standard for carrying out maintenance.**

2. Hang the ComfoAir Standard on the mounting bracket.
3. Mount the condensation drain under the ComfoAir Standard. The stated dimension of 235 mm is an indication only, and is dependent on the type of condensation drain selected.

2.6.2 Connection of the air ducts

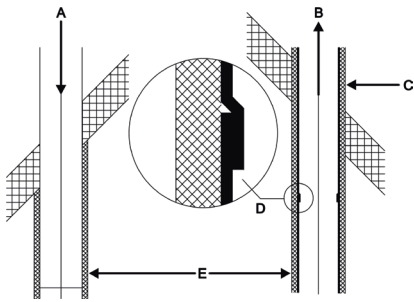

The following aspects must be taken into account, while installing the air ducts:

- **Install** the air exhaust duct so it drains in the direction of the ComfoAir Standard.
- **Insulate** the outside air supply and the air exhaust duct between the roof/wall passage to render the ComfoAir Standard damp proof. This prevents the formation of condensation on the outside of the ducts.
- To prevent unnecessary temperature loss in either the summer or the winter, we recommend fitting thermal and damp-proof insulation to the supply ducts from the ComfoAir Standard up to the supply valves.
- Install the air ducts with a minimum \varnothing of 150 mm, as little air resistance as possible and free from air leakage.
- Install a silencer of at least 1m straight directly onto the supply and return airconnections. For relevant advice, please contact Zehnder.
- When using flexible channels only Zehnder channel systems may be used. Any other flexible channel will disturb the basic operating principle of the balanced ventilation system.
- We recommend that the ventilation system is fitted with intake and exhaust valves made by Zehnder.

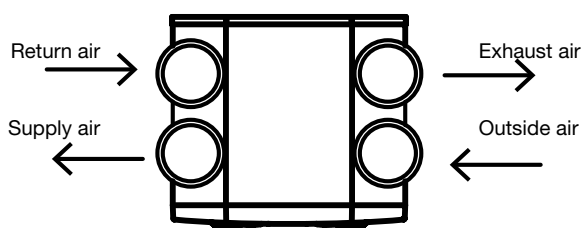

ComfoAir Standard - LEFT

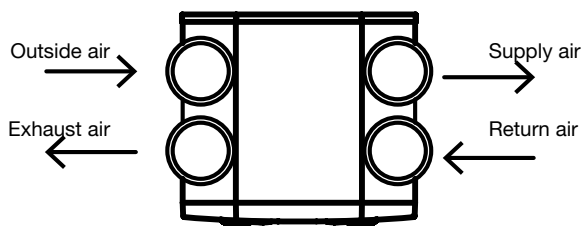

ComfoAir Standard - RIGHT

2.6.3 Connection of the condensation drain

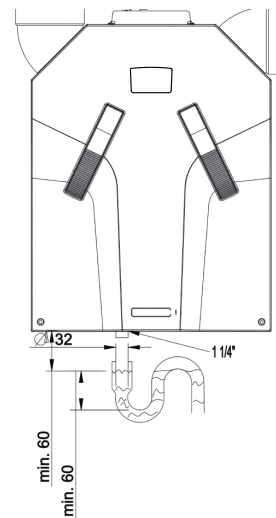

ComfoAir Standard - LEFT

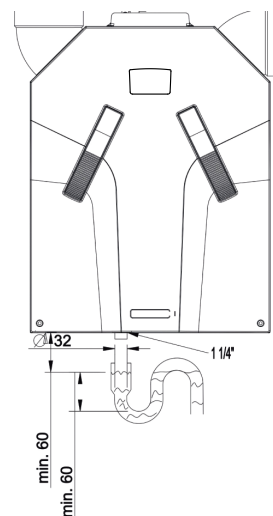

ComfoAir Standard - RIGHT

Standard heat exchanger

Warm exhaust air is cooled by the outside air in the heat exchanger. This causes the moisture in the indoor air to condense in the heat exchanger. The condensation water created in the heat exchanger is fed to a PVC condensation drain.

The connection for the condensation drain has an external diameter of 32 mm. It is located underneath the ComfoAir Standard.

- **Connect** the condensation drain, via a pipe or hose, to the water seal (siphon) of the domestic waste-water system.
- **Position** the upper edge of the water seal at least 40 mm underneath the condensation drain of the ComfoAir Standard.
- Make sure that the outer end of the pipe or tube exits is at least 60mm below the water level.



Ensure that the water seal connected to the domestic waste-water system is always full of water. This prevents the ComfoAir Standard from sucking in any leakage air.

Enthalpy exchanger

When the ComfoAir Standard is fitted with an enthalpy exchanger the humidity from the extracted air is partly transferred to the fresh supply air. In this case you delay the process of drying out the house in dry winter months, additionally there is no condensate that must be drained from the ComfoAir Standard. Therefore a condensation drain is not necessary with an enthalpy exchanger.

 **Ensure that the condensation drain is sealed. This prevents the ComfoAir Standard from sucking in any leakage air.**

The condensation drain can be sealed with a standard screw-cap.

2.7 Commissioning the ComfoAir Standard

After installation, the ComfoAir Standard must be commissioned.

This can be done via the P menus on the digital operating device. These P menus can be used to enter various settings (ventilation programmes, in particular) for the ComfoAir Standard. An overview of the available P menus is given below:

Menu	Options
P1	Reading statuses (from menu P2)
P2	Setting time delays
P3	Setting and reading the ventilation levels
P4	Setting and reading the temperatures
P5	Setting additional programmes
P6	Setting additional programmes
P7	Reading and resetting malfunctions (and system information)
P8	Setting the RF input and analogue inputs (0-10V)
P9	Reading statuses (from menu P5 and P6)







P menus P1, P2 and P9 can be accessed by the user, mainly to read statuses and set time delays. The remaining P menus P3 to P8 are intended **solely** for the installer.

 **The bypass valve will not work for the first 4 minutes after a power cut unless the programme mode is activated.**







2.7.1 Display on the unit

The ComfoAir Standard can be operated and commissioned by means of a display. The display is a digital operating device which is mounted on the ComfoAir Standard.



-  select menu
-  OK
-  supply off (led green)
-  up
-  down
-  supply on (led green)
-  comfort temperature

Shown in display

-  Ventilation setting absent
-  Ventilation setting low
-  Ventilation setting medium
-  Ventilation setting high
-  Menu symbol
-  Malfunction code (flashes)
-  Bypass

Access to the menus

Sequence	Press	Display	Description
1	MENU	P2	Time delay
2	s + s (3 seconds)	P3	Press the buttons simultaneously.
3	s	P4	Temperatures
4	s	P5	Settings
5	s	P6	Settings
6	s	P7	Malfunction / Reset / Self-test
7	s	P8	0 - 10V Inputs
8	s	P9	Status

Example

Setting the MEDIUM POSITION of the supply fan to 40%.

Sequence	Press	Display	Description
1	MENU	P2	Time delay
2	s + s (3 seconds)	P3	Press the buttons simultaneously.
3	OK	P30	Exhaust fan Position A
4	s (6x)	P36	Select P36
5	OK	50	Current setting
6	s (10 x or press continuously)	40	Select 40
7	OK	P35	Value is 40
8	MENU	P3	
9	MENU	1	Fan setting

 **Some P menus (such as P1 and P9) can only be read.**

Leaving Reading menu

■ At action point 6 press "MENU" (instead of "OK").

 **The display can not be used for setting the ventilation positions of the ComfoAir Standard. The arrowkeys are only for setting the additional programmes.**

2.7.2 P menus for the user

Menu P1 → Status of programmes

Sub-menu	Description	Status
		Activated
P11	Is menu 21 currently active?	Yes (1) / No (0)
P12	Is menu 22 currently active?	Yes (1) / No (0)
P13	Is menu 23 currently active?	Yes (1) / No (0)
P14	Is menu 24 currently active?	Yes (1) / No (0)
P15	Is menu 25 currently active?	Yes (1) / No (0)
P16	Is menu 26 currently active?	Yes (1) / No (0)

Menu P2 → Setting time delays

Sub-menu	Description	Time delay values		
		Minimum	Maximum	General Reset
P21 (Optional) Note: Only applies to systems fitted with a corded switch and a second switch in the bathroom.	Delay timer for the bathroom switch (to switch to high position). ■ 'x' minutes after operating the bathroom switch, the ComfoAir Standard switches to the high setting. - Low voltage input	0 Min.	15 Min.	0 Min.
P22 (Optional) Note: Only applies to systems fitted with a corded switch and a second switch in the bathroom.	Overrun timer for the bathroom switch (to switch to normal position). ■ 'x' minutes after operating the bathroom switch, the ComfoAir Standard switches back to the normal setting. - Low voltage input	0 Min.	120 Min.	30 Min.
P23 (Optional) Note: Only applies to systems fitted with a hardwired 3-position switch.	Overrun timer for ventilation position 3 (using a wired 3-position switch). ■ If ventilation setting 3 (high) is switched on briefly (< 3 sec), the ComfoAir Standard will switch to the high setting for 'x' minutes and then automatically returns to the normal setting. If any 3-position switch is operated during this lagging time the ComfoAir Standard will instantly revert to the ventilation position as set at that time.	0 Min.	120 Min.	0 Min.
P24	Filter warning ■ 'x' weeks after cleaning the filters the "filter dirty" alert will reappear.	10 weeks	26 weeks	16 weeks
P25 Note: Only applies to systems fitted with an RF switch.	Overrun timer for ventilation setting 3 (using "☺"). ■ After pressing "☺" briefly (< 2 sec.), the ComfoAir Standard will switch to the high setting for 'x' minutes and then automatically returns to the normal setting. If any 3-position switch is operated during this lagging time the ComfoAir Standard will instantly revert to the ventilation position as set at that time.	1 Min.	20 Min.	10 Min.
P26 Note: Only applies to systems fitted with an RF switch.	Overrun timer for ventilation setting 3 " using "☺". ■ After pressing "☺" continuously (> 2 sec.), the ComfoAir Standard will switch to the high setting for 'x' minutes and then automatically returns to the normal setting. If any 3-position switch is operated during this lagging time the ComfoAir Standard will instantly revert to the ventilation position as set at that time.	1 Min.	120 Min.	30 Min.
P27	N/A	0 Min.	120 Min.	30 Min.

Menu P9 → Status of programmes (from menu P5 and P6 additional programmes)

Sub-menu	Description	Status
		Activated
P90	Open fire programme active?	Yes (1) / No (0)
P91	Bypass Open?	Yes (1) / No (0)
P94	Analogue input (0-10V) active?	Yes (1) / No (0)
P95	Frost protection or Preheater active?	Yes (1) / No (0)
P97	Enthalpy programme active?	Yes (1) / No (0)

2.7.3 P menus for the installer

 **Menus with a line at minimum and maximum value are Reading menus.**







Menu P3 → Setting ventilation programmes

Submenu	Description	Ventilation programme values		
		Minimum	Maximum	General Reset
P30	N/A	0% or 15%	97%	nL / HL 15% / 15%
P31	Setting the capacity (in %) of the exhaust fan in low position.	16%	98%	nL / HL 35% / 40%
P32	Setting the capacity (in %) of the exhaust fan in medium position.	17%	99%	nL / HL 50% / 70%
P33	Setting the capacity (in %) of the exhaust fan to high position.	18%	100%	nL / HL 70% / 90%
P34	N/A	0% or 15%	97%	nL / HL 15% / 15%
P35	Setting the capacity (in %) of the supply fan in low position.	16%	98%	nL / HL 35% / 40%
P36	Setting the capacity (in %) of the supply fan in medium position.	17%	99%	nL / HL 50% / 70%
P37	Setting the capacity (in %) of the supply fan in high position.	18%	100%	nL / HL 70% / 90%
P38	Current capacity (in %) of the exhaust fan.	-	-	Current %
P39	Current capacity (in %) of the supply fan.	-	-	Current %

Menu P4 → Reading the temperatures

Submenu	Description	Temperature values		
		Minimum	Maximum	General Reset
P41	Comfort temperature	12 °C	28 °C	20 °C
P45	Current value of T1 (= outside air temperature)	-	-	Current °C
P46	Current value of T2 (= supply air temperature)	-	-	Current °C
P47	Current value of T3 (= return air temperature)	-	-	Current °C
P48	Current value of T4 (= exhaust air temperature)	-	-	Current °C



Menu P5 → Setting additional programmes

Submenu	Description	Additional programme values		
		Minimum	Maximum	General Reset
P50	Activation of the open fire programme.	0 (= No)	1 (= Yes)	0
P51	Confirming the presence of a Preheater element	0 (= No)	1 (= Yes)	0
	 Only change if a preheater element is installed afterwards or a general reset is given.			
P52	Setting the Preheater programme. <ul style="list-style-type: none"> ■ 0; Guaranteed protection. ■ 1; High protection. ■ 2; Nominal protection. ■ 3; Economy. 	0	3	2
	 In guaranteed protection mode the Preheater element is switched on soonest; this level offers the best guarantee of balanced ventilation. Vice versa, in economy mode the Preheater element switches on at the last possible moment; balanced ventilation is not guaranteed in this mode.			
	When commissioning the ComfoAir Standard, the Preheater programme can usually be left at level 2: NOMINAL MODE (factory setting). In areas with frequent cold spells in winter (frequent periods of -10°C or lower), level 1 should be selected: HIGH PROTECTION or even level 0: GUARANTEED PROTECTION.			
P54	Confirming the presence of a bypass.	0 (= No)	1 (= Yes)	1
	 The standard ComfoAir Standard configuration includes a bypass. Therefore, leave the value at '1'.			
P56	Setting the required air volume in the house. <ul style="list-style-type: none"> ■ nL: "normal air volume". ■ HL: "high air volume". 	nL	HL	HL
	 Setting the air volume is the starting point for programming the air specifications and setting the fans.			
P57	Setting the ComfoAir Standard type. <ul style="list-style-type: none"> ■ Li = "Left-hand version". ■ Re = "Right-hand version". 	Li	Re	Li
	 With delivery the ComfoAir Standard is correctly pre-programmed at the factory.			
	 After an general reset the pre-programming is lost and the setting must be reset.			
	The right setting is mentioned on the identification plate on top of the ComfoAir Standard.			
P58	n/a	0	1	0
P59	Confirming the presence of an enthalpy exchanger. <ul style="list-style-type: none"> ■ 0; Enthalpy exchanger not fitted ■ 1; Enthalpy exchanger with RH sensor. ■ 2; Enthalpy exchanger without RH sensor. 	0 (= No)	2 (= Yes)	0
	 Only an enthalpy exchanger without RH sensor can be fitted.			

Menu P6 → Setting additional programmes

Submenu	Description	Additional programme values		
		Minimum	Maximum	General Reset
P60	Confirming the presence of a geothermal heat exchanger. <ul style="list-style-type: none"> ■ 0; Geothermal heat exchanger not fitted ■ 1; Geothermal heat exchanger fitted ■ 3; Geothermal heat exchanger unregulated. 	0 (= No)	3 (= Yes)	0
	 Only an unregulated geothermal heat exchanger can be fitted.			

Menu P7 → Reading malfunctions (and system information)

Submenu	Description	(Malfunction) information values		
		Minimum	Maximum	General Reset
P70	Current software version.	Version number of the software (without "v")		
P71	Most recent malfunction.	Code in accordance with alarm and malfunction alert		
P72	Malfunction before the most recent one	Code in accordance with alarm and malfunction alert		
P73	Malfunction before the most recent two	Code in accordance with alarm and malfunction alert		
P74	Ressetting malfunction(s) ■ Set value tot '1' and press "OK" on the display.	0	1 (= activate)	0
P75	General reset. ■ Press "OK" on the display for at least 5 seconds to carry out a general reset. All original software settings are re-stored following a general reset.	0	1 (= activate)	0
<p>Note:</p> <p> After a general reset, the ComfoAir Standard will ask you to reset the "nL / HL" (see P56) and "Li / Re" (see P57) settings.</p> <p> Following a general reset, all settings and programmes need to be checked and set to the right value.</p>				
P76	Self-testing the ComfoAir Standard	0	1 (= activate)	0
<p> ■The LED's on the display will start blinking. ■The ComfoAir Standard will run at maximum Rotation Per Minute (RPM). ■The bypass valve will open and close. ■The preheater valve will open and close after the bypass has closed (If a preheater element is fitted).</p>				
P77	Ressetting filter dirty counter	0	1 (= activate)	0
<p>Note: This resets the counter that triggers a dirty filter alert on the ComfoAir Standard. This allows the filter to be cleaned or replaced before the dirty filter alert appears.</p>				

Menu P8 → Setting the RF input and digital inputs (0-10V)

Submenu	Description	Analogue input values		
		Minimum	Maximum	General Reset
850	RF input 1 0= not fitted 1= fitted	0	1	0
851	0= controlling 1= programming (RF input 1)	0	1	0
852	set point RF input 1 (programming)	0	100	50
853	min. setting RF input 1	0	99	0
854	max. setting RF input 1	0	100	100
855	0=positive RF input 1=negative setting RF input 1	0	1	0
856	Read-out RF input	0	100	-

2.8 Programming air specifications

After installation, the ComfoAir Standard must be programmed.

Zehnder ComfoAir Standard 300 and 375

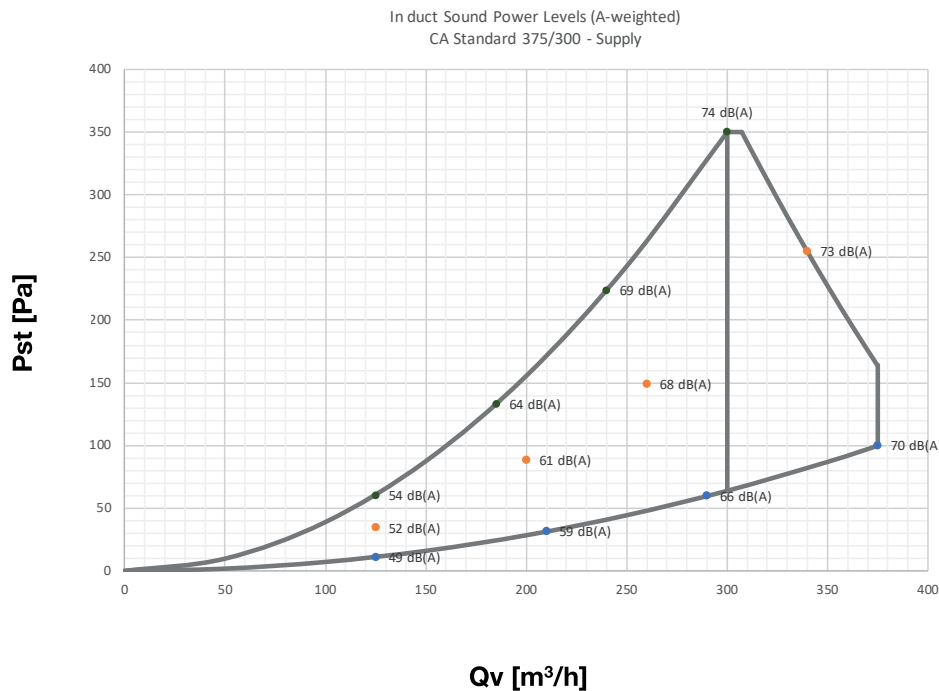

This can be done using the air specifications of the ComfoAir Standard above.



The default settings of the ComfoAir Standard nL are:

Position LOW	35%
Position MEDIUM	50%
Position HIGH	70%

The default settings of the ComfoAir Standard HL are:

Position LOW	40%
Position MEDIUM	70%
Position HIGH	90%

Follow this procedure to programme the ComfoAir Standard (after installation):

- Set the ComfoAir Standard in programming mode.
 - Display: Press simultaneously for at least 3 seconds on " " and " " until "InR" appears on the display.

 **In programming mode, the bypass and Preheater element valves are always closed. After 30 minutes, the ComfoAir Standard automatically terminates the programming mode.**

- Close all windows and outside doors.
- Close all inside doors.
- Check the presence of structural overflow provisions.

 **The structural overflow provisions must be at least 12 cm² per l/s.**

- Check if both fans function in the three speed settings.

- Switch the ComfoAir Standard to high speed.
- Install all valves and set the valves according to the settings given or as set in the reference house.

If no data are known:

- Install the valves and **open** them as far as possible.
- Measure the air volumes; starting with the intake air and then the exhaust air.
- If the measured air volumes deviate from the nominal air volumes by more than +/-10%, and the majority of the deviations is positive, **ensure** that all deviations are positive. If the majority of all deviations is negative, **ensure** that all deviations are negative. **Ensure** that one supply valve and one exhaust continue to be fully open.

- Change the fan settings in P menus P30 to P37 of the digital operating device.
 - Select the lowest possible setting in order to conserve energy.
 - Ensure that the ratios between low, medium and high remain equal.

 **Use the chart of the air specifications to set the fans.**

- In the event that the currently set air volumes still deviate too much: Adjust the valves.
- Check the entire installation again, after all valves have been set.
- Switch the ComfoAir Standard (back) to

ventilation position 2.

- Display: Press simultaneously for 3 seconds on "🔒" and "🔒" until "InR" disappears of the display.

2.9 Maintenance by the installer

The following maintenance must be carry out by the installer:

- Inspecting and (if necessary) cleaning the heat exchanger;
- Inspecting and (if necessary) cleaning the fans;
- Inspecting and (if necessary) cleaning the preheater element filter (If a preheater element is fitted).

A concise explanation of these maintenance activities is given in the paragraphs below.

⚠️ Unplug the unit from the wall outlet to disconnect it from the power supply. If the unit does not have a plug, use a switch according to EN 60335-1 (with switch-off of all poles and 3 mm overvoltage category III).

👉 Check the condensation drain once every 2 years.

⚠️ Failure to carry out (periodic) maintenance on the ComfoAir Standard ultimately compromises the performance of the ventilation system.

2.9.1 Inspecting and cleaning the heat exchanger

👉 Check the heat exchanger once every 2 years.

1. Disconnect the power (A) from the ComfoAir Standard.
2. Remove the handles (B) from the ComfoAir Standard.
3. Remove the filters from the ComfoAir Standard.
4. Release the front panel by unscrewing the screws (C).
5. Slide the front panel upwards and **remove** the front panel from the ComfoAir Standard.

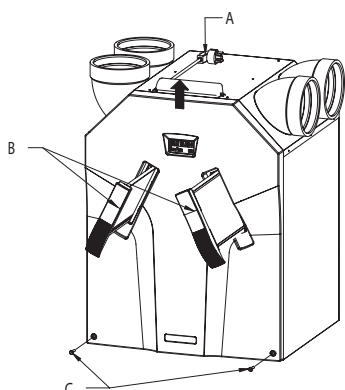

6. Release the cover panel by unscrewing the screws (D).
7. Remove the cover panel.

👉 When reassembling the front cover, the lower section must first be inserted behind the raised edge to ensure a good seal.

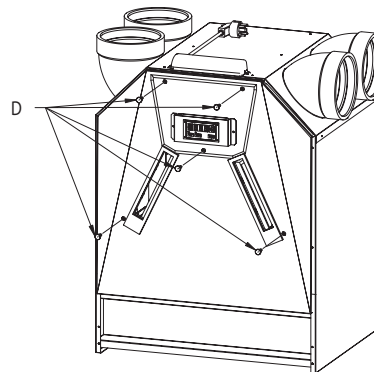

ComfoAir Standard – Left-hand version

8. Pull the strap (E) to remove the heat exchanger and the leakage tray (F).
9. Remove the bypass duct (G) in the **left-hand** version of the ComfoAir Standard.

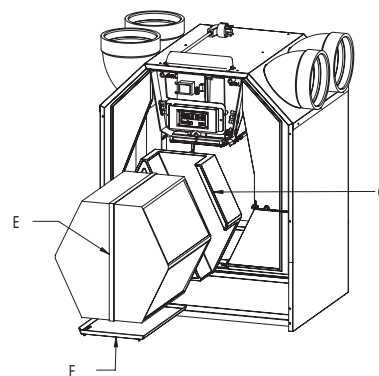

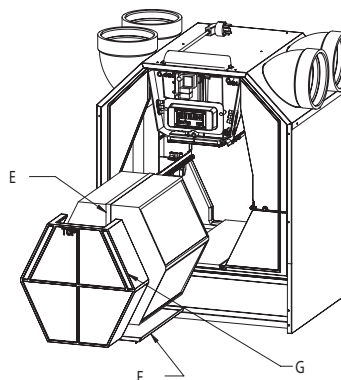

ComfoAir Standard – Right-hand version

8. Remove the bypass duct (G) in the **right-hand** version of the ComfoAir Standard.
9. Pull the strap (E) to remove the heat exchanger and the leakage tray (F).



10. Remove the heat exchanger from the leakage tray (F).

 **The heat exchanger may contain some residual water!**

 **When reassembling the leakage tray the openings in the leakage tray must be on the side of the condensation drain.**

11. Inspecting and if necessary clean the heat exchanger.
 - Use a soft brush to clean the lamellae.
 - Use a vacuum cleaner or air gun (no high pressure) to remove dirt and dust.

 **Always clean against the direction of the airflow. This prevent dirt from getting stuck in the heat exchanger.**

Only standard exchanger with a green cover and Enthalpy exchanger with a blue cover:

- a. Submerge the heat exchanger several times in hot water (max. 40 °C).
- b. Rinse the heat exchanger with clean hot tap water (max. 40 °C).
- c. Clasp the heat exchanger between both hands (on the coloured side surfaces) and shake the water from the heat exchanger.

 **Only an enthalpy exchanger with a bleu cover can be washed with water. When having an Enthalpy exchanger with a white cover do never wash it with water.**

 **Do not use aggressive cleaning agents or solvents.**

 **If the fans or preheater element filter also need maintenance do not re-install the heat exchanger yet.**

12. If no more maintenance is necessary install all parts in reverse order, reconnect the power and carry out the self-test in accordance with menu P76.

 **Fasten the screws to a maximum of 1.5 Nm. This is roughly equal to setting 2 of an average battery-powered drill.**

2.9.2 Inspecting and cleaning the fans

 **Check the fans once every 2 years.**

1. Remove the heat exchanger as instructed in the maintenance chapter of the heat exchanger.
2. Remove the small plastic panel (H) in front of the control circuit board panel by unscrewing the two screws.
3. Release the connectors (K) and the earth wire on the

control circuit board panel and fully remove the cables including the two grommets (K).

4. Remove the entire scroll casing by pressing the click fasteners (L).
5. Remove the inflow nozzle by pressing the click fasteners surrounding the scroll casing.
6. Inspecting and if necessary clean the fans.
 - Use a soft brush to clean the fan impellers.
 - Use a vacuum cleaner to remove dust.

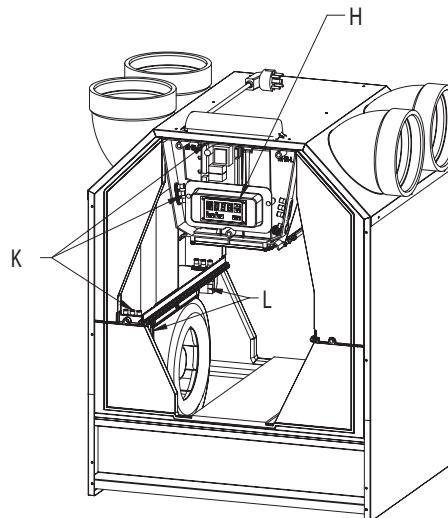

 **Do not damage the fan impellers or temperature sensor.**

 **If the preheater element filter also need maintenance do not re-install the heat exchanger yet.**

7. If no more maintenance is necessary install all parts in reverse order, reconnect the power and carry out the self-test in accordance with menu P76.

 **Fasten the screws to a maximum of 1.5 Nm. This is roughly equal to setting 2 of an average battery-powered drill.**

2.9.3 Inspecting and cleaning the preheater element filter

 **Clean the filter of the Preheater (if fitted) once every 4 years.**

1. Remove the heat exchanger as instructed in the maintenance chapter of the heat exchanger.
2. Remove the small plastic panel (I) in front of the control circuit board panel by unscrewing the two screws.
3. Release the connectors (J) and the earth wire on the control circuit board panel and fully remove the cables including the two grommets (K).
4. Remove the cable (P) from the control circuit board panel.

5. Remove the base (Q) of the Preheater element.
 - The base is fitted in the electronic carriage with four snap connections. Two snap connections are located at the front (visible) and two at the back (not visible).
6. Inspecting and if necessary clean the preheater element filter.
 - Clean the filter with a brush.
 - Remove any deposit using a damp cloth.
7. Install all parts in reverse order.
8. Reconnect the power to the ComfoAir Standard.



Fasten the screws to a maximum of 1.5 Nm. This is roughly equal to setting 2 of an average battery-powered drill.

9. Carry out the self-test in accordance with menu P76.

2.10 Malfunctions

Malfunctions in the ComfoAir Standard are reported as follows:

- The malfunction alert appears on the display.
- The malfunction indicator on the 3-position switch lights up;

Malfunction alerts may not appear on the digital operating device in all cases, even though there is a malfunction (or problem). A concise explanation of both types of malfunction (or problem) is given in the paragraphs below.

2.10.1 Malfunction alerts on the digital operating device

In the event of a malfunction, the corresponding malfunction code will be displayed on the digital operating device of the ComfoAir Standard.

Below is a list of the malfunction alerts on the digital operating device.

In the chapter about trouble shooting is explained how to solve these malfunctions

Code	Description
A0	N/A
A1	NTC sensor T1 is defective. (= outside air temperature)
A2	NTC sensor T2 is defective. (= supply air temperature)
A3	NTC sensor T3 is defective. (=return air temperature)
A4	NTC sensor T4 is defective. (= exhaust air temperature)
A5	Malfunction in the bypass motor.
A6	Malfunction in the Preheater element motor.
A7	Preheater element does not heat sufficiently.
A8	Preheater element becomes too hot
E1	Exhaust fan not rotating.
E2	Supply fan not rotating.
EA2	No communication between the enthalpy sensor and the ComfoAir Standard.
,Fil',tEr'	Internal Filter is dirty.

2.10.2 3-position switch with malfunction indicators

The 3-position switches that are fitted with a malfunction indicator show when a malfunction or filter dirty alert has occurred. Depending on the type of the 3-position switch, this is done in one of the following two ways:

- 3-position switch with malfunction indicator.

In the event of a malfunction or filter dirty alert the indicator lights up;

- Wireless 3-position switch with malfunction indicator.

The malfunction indicators will light up once this 3-position switch is used. One indicator will light up green to indicate communication has been established. Subsequently, in the event of a malfunction or filter dirty alert both indicators will flash red 3 times. After that, both indicators will light up green once more.



2.10.3 What to do in the event of a malfunction / Trouble shooting

Below are a number of trouble-shooting tips for the malfunction alerts described previously which can appear on the digital operating device in the event of a malfunction.

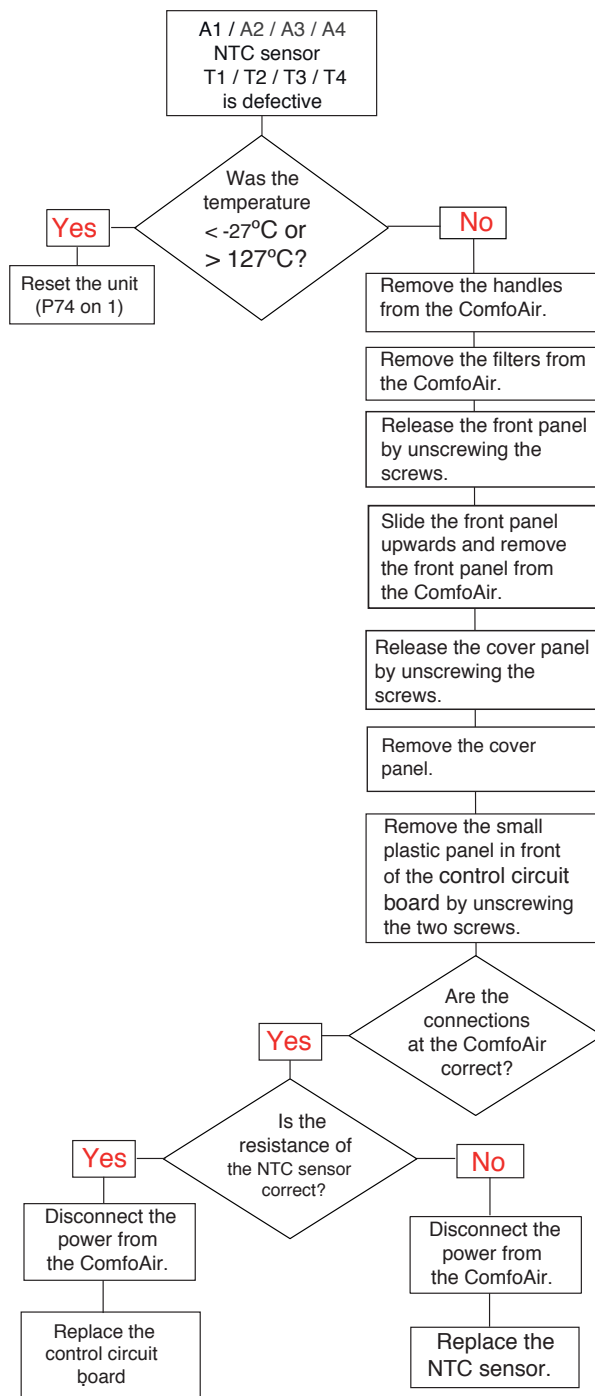

Resistance tabel for
(NTC) temperature sensors:

Temperature [°C]	Resistance [KΩ]		
	MIN.	MID.	MAX.
10	19,570	19,904	20,242
15	15,485	15,712	15,941
18	13,502	13,681	13,861
19	12,906	13,071	13,237
20	12,339	12,491	12,644
21	11,801	11,941	12,082
22	11,291	11,420	11,550
25	9,900	10,000	10,100
30	7,959	8,057	8,155

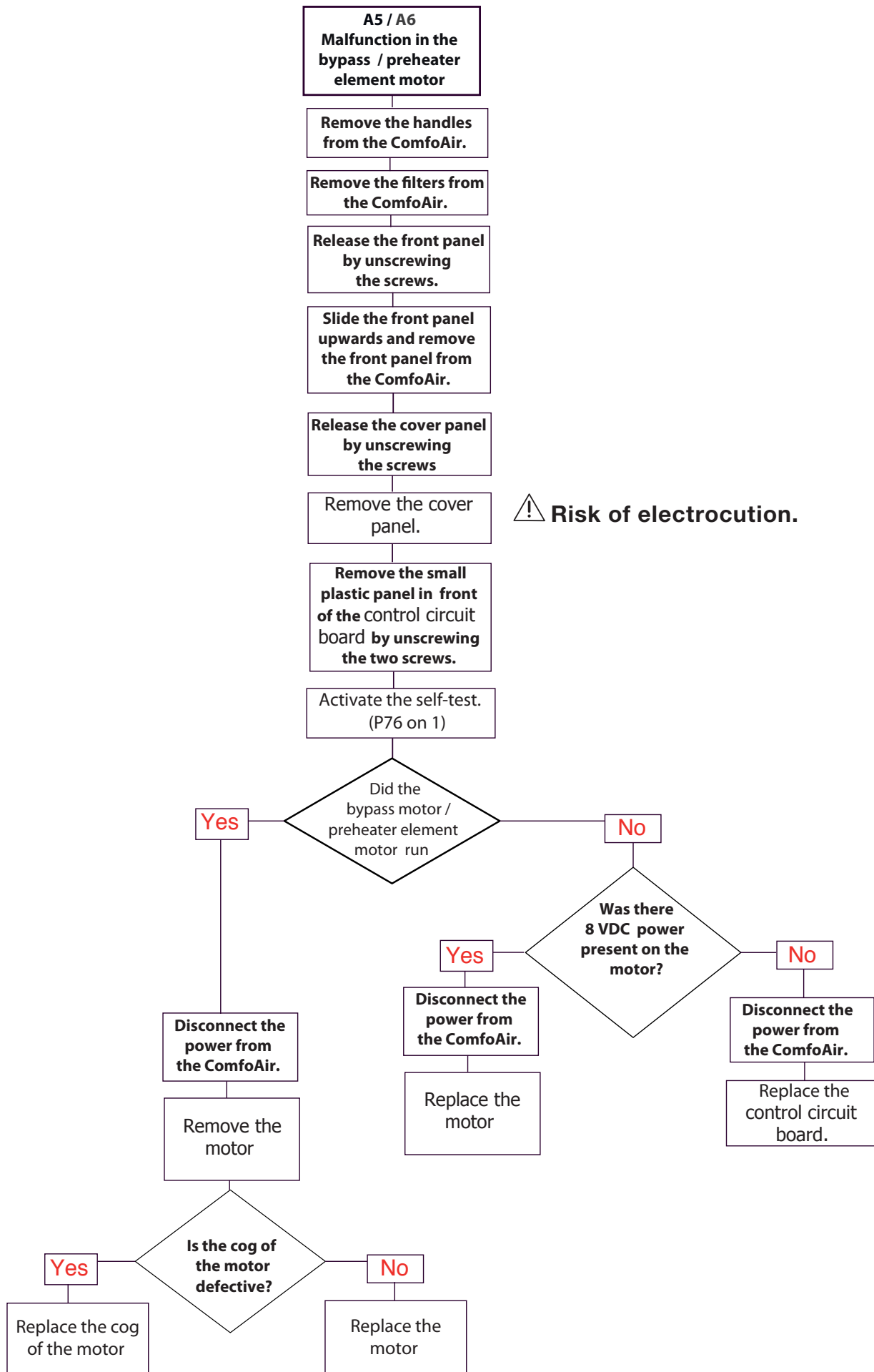

 This error will appear when after 3 minutes of switching on the preheater element the temperature increase of T1 is less than 4°C. This can also happen when there is too much cold air passing the preheater element. In that case reduce the airflow and reset the unit (P74 on 1).

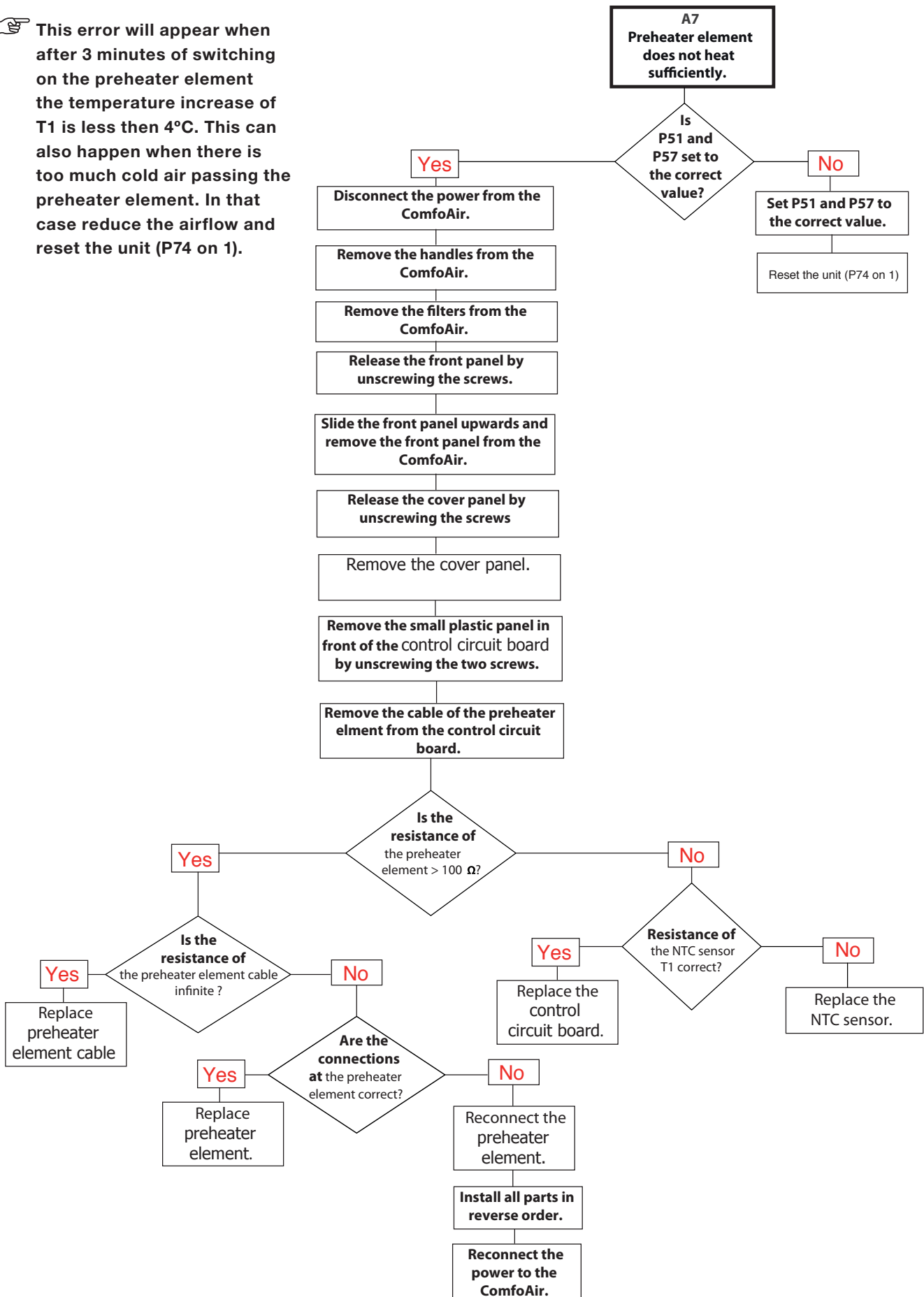

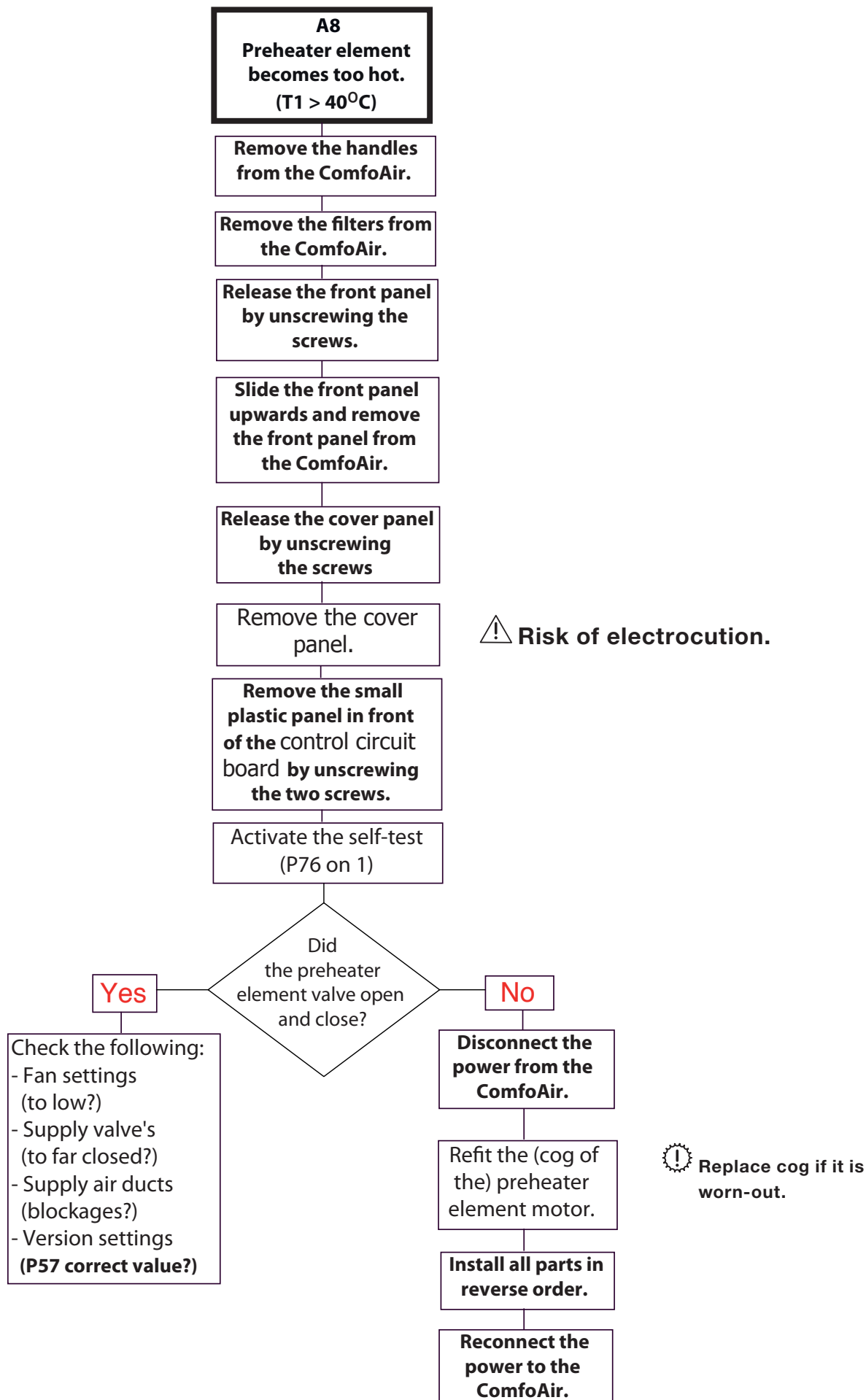

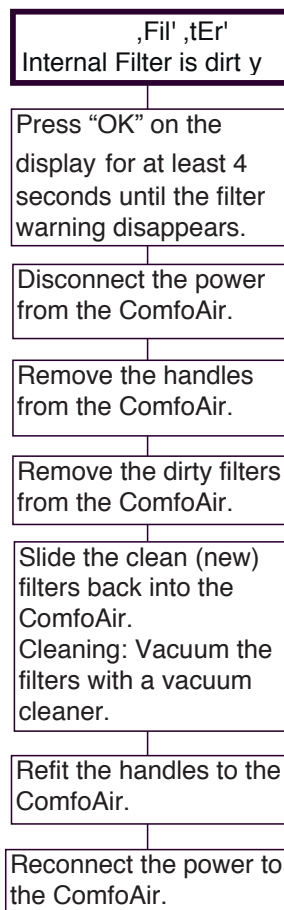
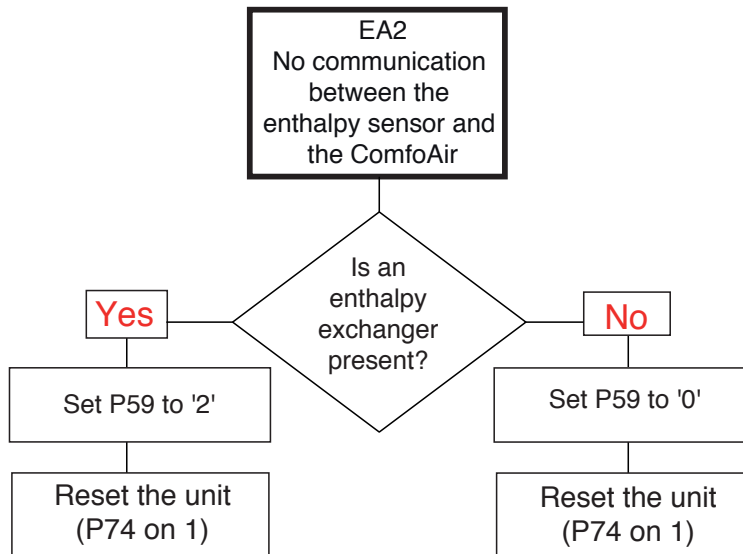
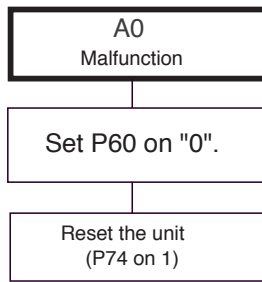

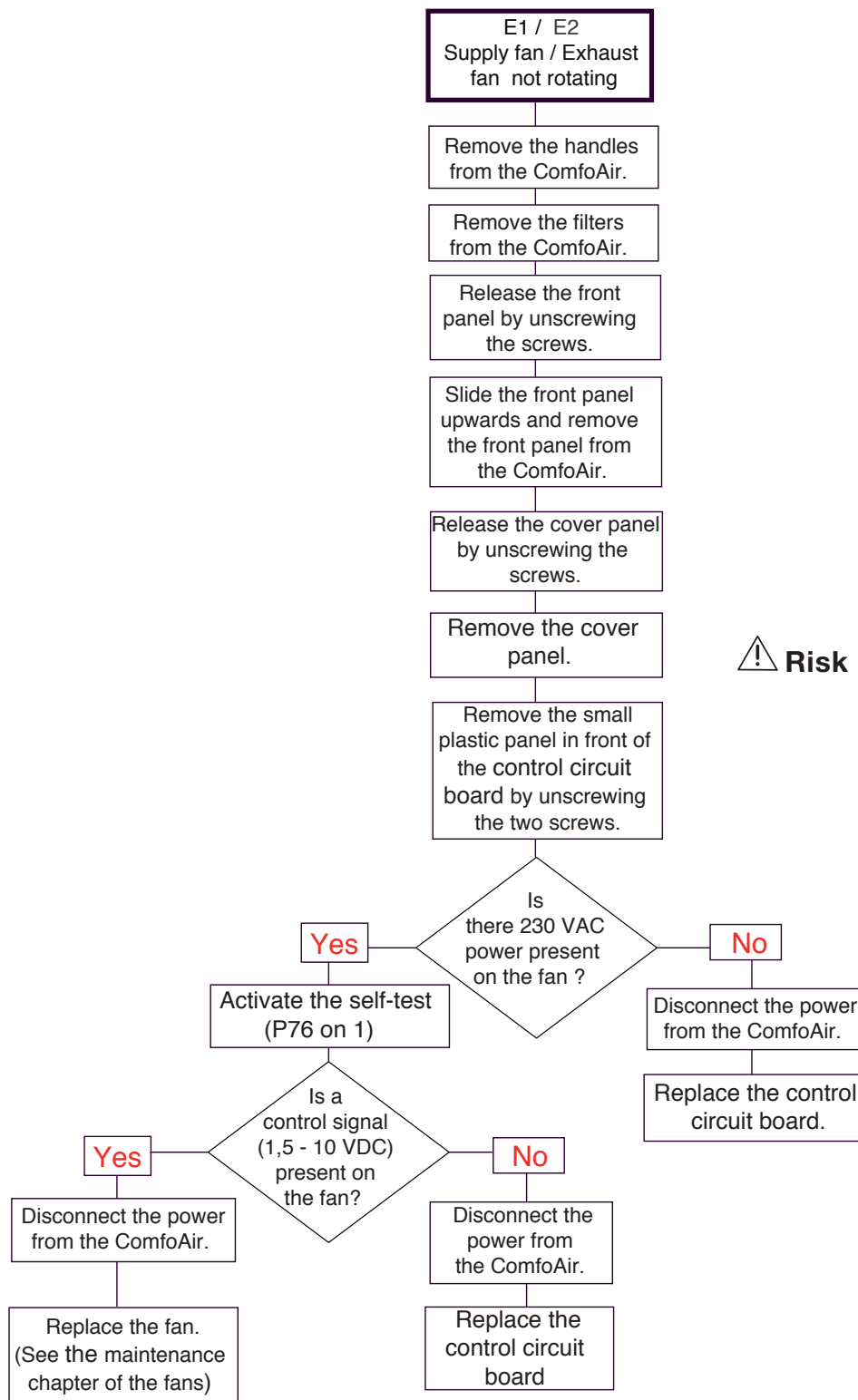

 **Risk of electrocution.**

2.10.4 Malfunctions (or problems) without alerts

An overview of the malfunctions (or problems) without notifications is given below.

Problem/Malfunction	Indication	Check / action
System switched off	Power supply on	The control circuit board is defective and must be replaced.
	No power supply	Mains power is off.
High intake temperature in summer	Bypass remains closed	Reduce the comfort temperature.
	ComfoAir Standard is still in Winter mode: Bypass remains closed	Checking the Mode of the ComfoAir Standard is possible with special read-out software. ■ Wait until ComfoAir Standard switches to Summer mode.
Low intake temperature in winter	Bypass stays open	Increase the comfort temperature.
Little or no air supply; shower remains damp	Filters blocked	Replace the filters.
	Valves blocked	Clean the valves.
	Exchanger clogged by dirt.	Clean the exchanger.
	Exchanger frozen	Defrost the exchanger.
	Fan dirty	Clean the fan.
	Ventilation ducts blocked	Clean the ventilation ducts.
	ComfoAir Standard is in frost-protection operation	Wait until the weather warms up.
Too noisy	Fan bearings defective	Replace the fan (bearings).
	Fan settings to high	Change the fan (settings).
	Slurping noise ■ Siphon is empty ■ Siphon does not seal properly	Reconnect the siphon.
	Whistling noise ■ An air gap somewhere	Seal the air gap.
	Airflow noise ■ Valves do not close onto duct. ■ Valves not open far enough	Reinstall the valves. Reset the valves.
Condensation leak	Condensation drain clogged	Unblock the condensation drain.
	Condensation from exhaust duct does not run into leakage tray	Check whether the connections are correct.
Corded 3-position switch not working	Cabling is not correct	Check the wire-circuit of the 3-position switch by measuring the voltage: ■ Voltage only on N & L3: [Fans rotate in position 1]. ■ Voltage only on N & L3 & L2: [Fans rotate in position 2]. ■ Voltage only on N & L3 & L1 or N & L3 & L2 & L1: [Fans rotate in position 3].
	Switch is defective	
Wireless 3-position switch not working	Battery is discharged	Check the battery. ■ Replace the battery (if necessary).
	Switch is not correctly tuned.	Remove the power shortly from the ComfoAir Standard. Shortly after reconnecting the power tune the switch again.

2.11 Service parts

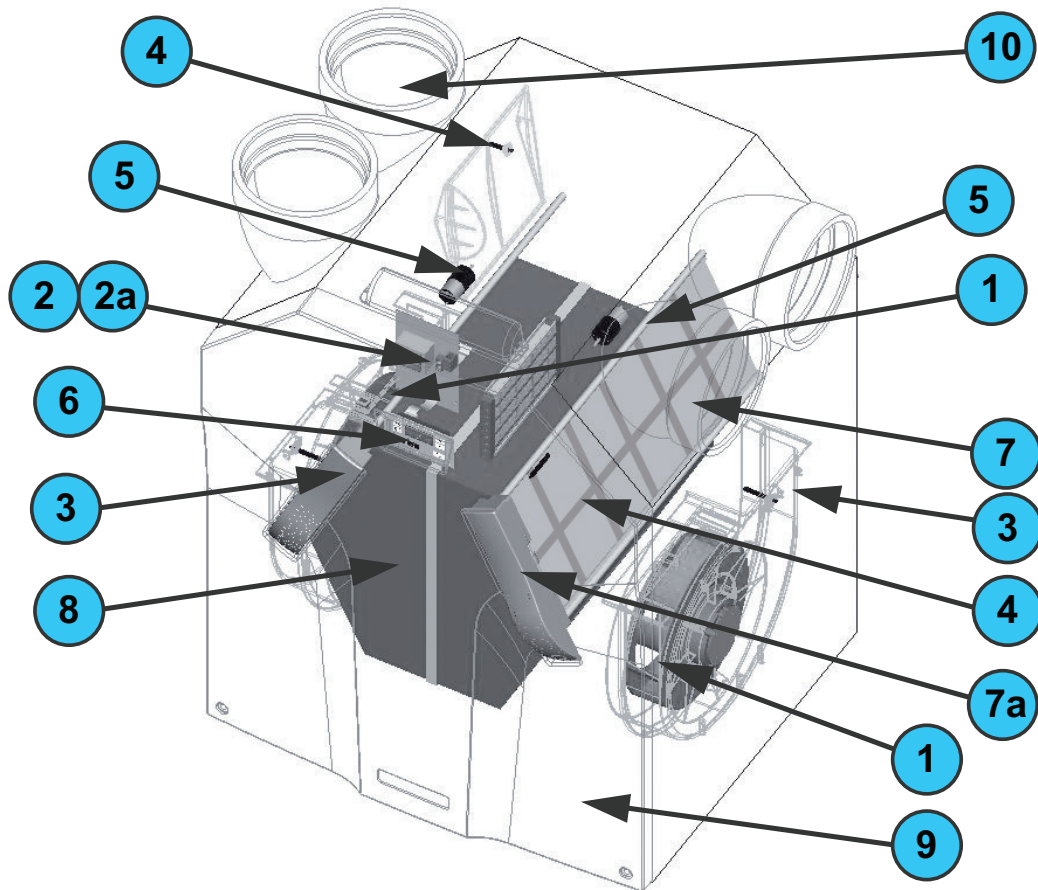

The following table contains an overview of the spare parts available for the ComfoAir Standard.

Number	Part
1	Fan (left/right)
2	ComfoAir Standard PCB 300 or 375
2a	ComfoSense connection cable
3	Temperature sensor T2 / T4 (in scroll casing of both fans)
4	Temperature sensor T1 / T3 (in top of unit; near the electronic carriage)
5	Servo motor & cable (for the bypass and the Pre-heater element)
6	Display
7a	Filter handle
7	Plate filters ISO Coarse/ ISO ePM1
8	Heat exchanger
8	Enthalpy exchanger
9	White cover
10	EPP bend

2.12 Wiring diagram: ComfoAir Standard - LEFT-HAND version

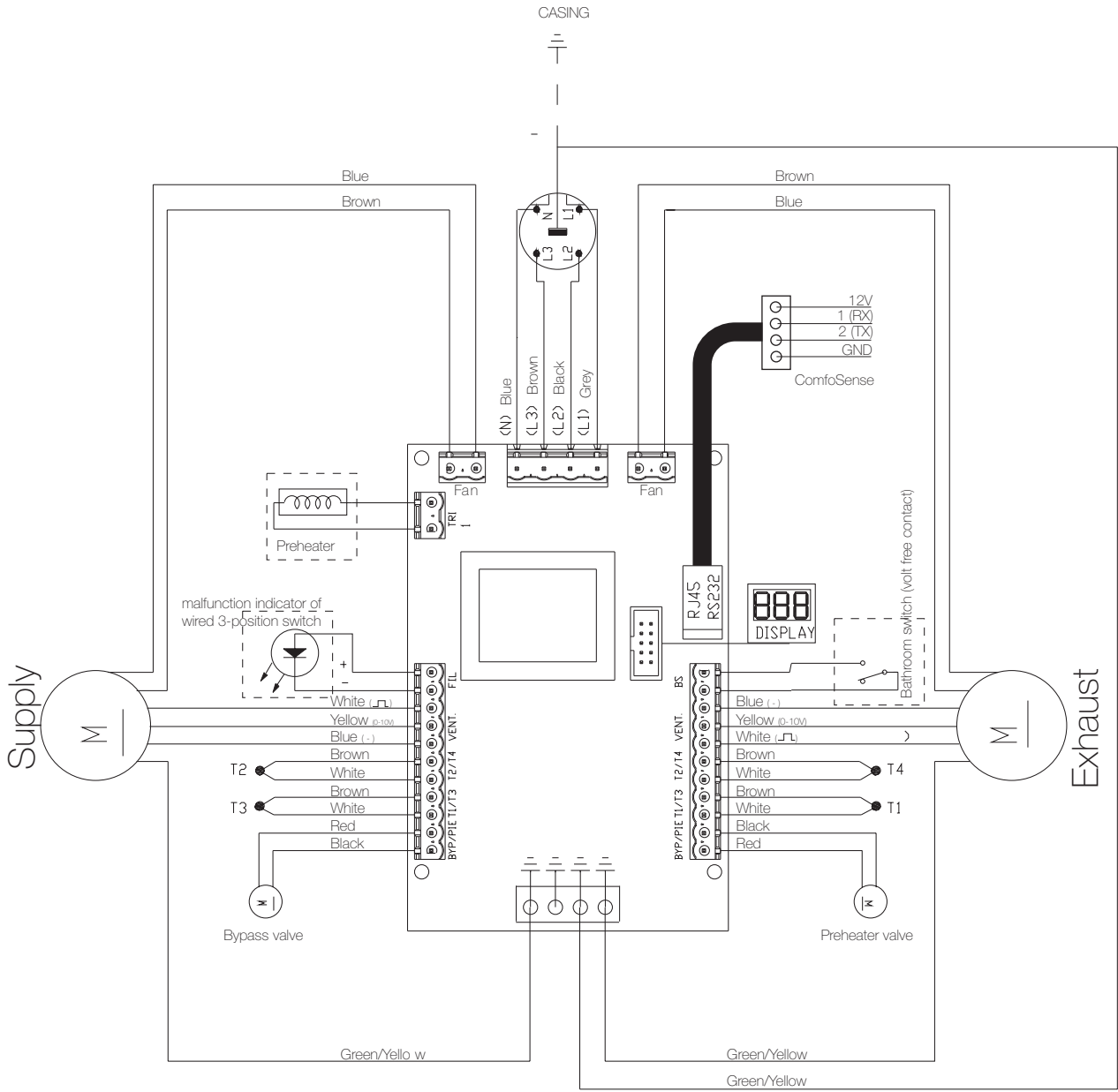

2.13 Wiring diagram: ComfoAir Standard - RIGHT-HAND version

